

SA Series(Wiring System: DIN Connector Type) Wet Type Solenoid Valve

100 to 160ℓ/min
35MPa

Features

- ① Very long life
The movable iron core of the wet type solenoid is immersed in oil, which keeps it lubricated and cushions it from impact and vibration, ensuring very long life.
- ② Low switching noise
The wet-type solenoid valve provides very low core switching noise, for quiet operation.
- ③ Shockless
A switching speed adjustment mechanism enables direct, shockless operation (Option F).
- ④ No surge voltage
Sparking and surge voltage during solenoid switching is canceled for stable switching (Option G).
- ⑤ Easy coil replacement
A DIN connector type coil enables one-touch coil replacement.
- ⑥ Wide-ranging backward compatibility makes it simple to replace previous valve models with this one. Combining this valve with a modular valve contributes to the compact configuration of the overall device.
- ⑦ Global support (G01 size)
Meets overseas safety standards (CE, UL, and CSA). It can be safely used anywhere in the world. Contact your agent for certified products.

Specifications

Model No.		SA-G01				SA-G03					
		Standard Type		Shockless Type		Standard Type				Shockless Type	
						AC Solenoid Type		DC Solenoid Type (With built-in rectifier)			
JIS Symbol	Operation Symbol	Maximum Flow Rate ℓ/min	Maximum Working Pressure MPa(kgf/cm ²)	Maximum Flow Rate ℓ/min	Maximum Working Pressure MPa(kgf/cm ²)	Maximum Flow Rate ℓ/min	Maximum Working Pressure MPa(kgf/cm ²)	Maximum Flow Rate ℓ/min	Maximum Working Pressure MPa(kgf/cm ²)	Maximum Flow Rate ℓ/min	Maximum Working Pressure MPa(kgf/cm ²)
	-A2X-	30		30		40		85		85	
	-H2X-					85					
	-E2X-										
	-A3X-	80									
	-H3X-										
	-E3X-										
	-A3Z-	65									
	-H3Z-										
	-E3Z-										
	-A4-	50									
	-H4-										
	-A5-										
	-H5-	35{357}		50	25{255}	130		160		130	25{255}
	-C2-										
	-C5-										
	-C9-	100									
	-C1S-										
	-C6S-										
	-C1-	AC Solenoid 65									
	-C6-										
	-C4-	50									
	-C7Y-										
	-C8-										

Note) The maximum flow rate of each valve depends on the pressure. For details, see pages E-21 and E-22.

		SA-G01			SA-G03		
		AC Solenoid	DC Solenoid		AC Solenoid	DC Solenoid	
			Built-in Rectifier			Built-in Rectifier	
		C*	E*	D*	C*	E*	D*
Maximum Working Pressure	P, A, B ports	35(25)MPa{357(255)kgf/cm ² }(Note1)					
Maximum Allowable Backpressure	T port	21MPa{214kgf/cm ² }			16MPa{163kgf/cm ² }		
Switching frequency (cycles/minute)	Standard Type	300	120	300	300	120	240
	Shockless Type	–		120	–		–
Option	Indicator light	R			R		
	Shockless	–	F		–	F	
	Surgeless	G	–	G	G	–	G
	G Screw Connector	J	–	J	J	–	J
	With manual push-button	N			N		
Weight (kg)	Double Solenoid	1.8	2.0		4.2	5.5	
	Single Solenoid	1.4	1.5		3.5	4.1	
Operating Environment	Dust Resistance/Water Resistance	JIS C 0920 IP65 (Dust-tight, Waterjet-proof) (Note 2)					
	Ambient Temperature	-20 to 50°C					
	Operating Fluid	Temperature Range	-20 to 70°C				
		Kinematic Viscosity Range	15 to 300mm ² /s				
	Filtration	25 μm or less					
Mounting bolt	Size × Length	M5×45 (Four)			M6×70 (Four) (M8×70 (Four))		
	Tightening Torque	M5 5 to 7N·m{51 to 71kgf·cm}			M6 10 to 13N·m{102 to 133kgf·cm} (M8 20 to 25N·m{204 to 255kgf·cm})		

- Note) 1. Maximum operating pressure depends on the valve type. For details, see page E-13.
 2. The power supply type for E* is IP64 (dust-tight, splash-proof).
 3. For mounting bolts, use bolts of 12.9 strength classification or equivalent.
 4. Mounting bolts are not included with the 01 size. Bolts are included with the 03 size.

● Handling

- 1 In order to realize the full benefits of the wet type solenoid valve, configure piping so oil is constantly supplied to the T(R) port. Never use a stopper plug in the T(R) port.
- 2 Ensure that surge pressure in excess of the maximum allowable back pressure does not reach the T port.
- 3 Note that the maximum flow rate is limited when used as a four-way valve, or by blocking ports for use as a two-way valve or one-way valve.
- 4 Always keep the operating fluid clean. Allowable contamination is class NAS12 or less.
- 5 When using petroleum type operating fluid, use JIS K 2213 Class 1 or Class 2, or equivalent.
- 6 For details about using fire-resistant hydraulic fluid, see page D-1 for more information.
- 7 Use this valve only within the allowable voltage range.
- 8 Do not allow the AC solenoid to become charged until you install the coil into the valve.
- 9 In the case of operation symbols A2X, H2X, and E2X, run drain piping from the valve T port.
- 10 Maintaining a switching position under high pressure for a long period can cause abnormal operation due to

hydraulic lockup. Contact your agent when you need to maintain a switching position for a long period.

- 11 When using a detent type (E2X, 3X, E3Z), use constant energization in order to securely maintain the switching position.

12 Note that manual pin operating pressure changes in accordance with tank line back pressure.

13 The series described in the table below are available for use as the RSA Series solenoid control relief valve.

RSA-***-AR*(H)-** ¹⁵ ₂₃	SA-G01-AR-**-31
RSA-***-AQ*(H)-** ¹⁵ ₂₃	SA-G01-A3X-**-31
RSA-***-F(H)-** ¹⁵ ₂₃	SA-G01-A8X0-**-31

- 14 The coil surface temperature increases if this valve is kept continuously energized. Install the valve so there is no chance of it being touched directly by hand.

15 Use the following table for specification when a sub plate is required.

Model No.	Pipe Diameter	Maximum Working Pressure MPa(kgf/cm ²)	Recommended Flow Rate (ℓ/min)	Weight (kg)	Applicable Valve Type
MSA-01X-10	1/4	25{255}	20	1.2	SA-G01-***-**-31
MSA-01Y-10	3/8		30		
MSA-03-10	3/8		45	2.3	SA-G03-***-**-J21
MSA-03X-10	1/2		80		
MS-03-30	3/8		45	2.3	SA-G03-***-**-21
MS-03X-30	1/2		80		

● Solenoid Assembly Specifications

Solenoid Type	Power Supply Type	Voltage (V)	Frequency (Hz)	For SA-G01				For SA-G03					
				Solenoid Coil Type	Drive Current (A)	Holding Current (A)	Holding Power (W)	Allowable Voltage Range (V)	Solenoid Coil Type	Drive Current (A)	Holding Current (A)	Holding Power (W)	Allowable Voltage Range (V)
AC	C1	AC100	50	EAC64-C1	2.2	0.52	25	80 to 110	EBB64-C1	5.4	0.92	36.0	80 to 110
			60		2.0	0.38	22			90 to 120	4.6	0.62	
		AC110	60	2.2	0.46	28	5.0	0.78			42.0	90 to 120	
	C115	AC110	50	EAC64-C115	2.0	0.47	25	90 to 120	EBB64-C115	5.0	0.85	36.0	90 to 120
			60		1.8	0.35	22			100 to 130	4.2	0.57	
		AC115	60	2.0	0.42	28	4.6	0.72			42.0	100 to 130	
	C2	AC200	50	EAC64-C2	1.1	0.26	25	160 to 220	EBB64-C2	2.7	0.46	36.0	160 to 220
			60		1.0	0.19	22			180 to 240	2.3	0.31	
		AC220	60	1.1	0.23	28	2.5	0.39			42.0	180 to 240	
	C230	AC220	50	EAC64-C230	1.0	0.24	25	180 to 240	EBB64-C230	2.5	0.42	36.0	180 to 240
			60		0.91	0.17	22			200 to 260	2.1	0.29	
		AC230	60	1.0	0.21	28	2.3	0.36			42.0	200 to 260	
DC with Built-in Rectifier	E1	AC100	50/60	EAC64-E1-1A	0.31		27	90 to 110	EBB64-E1	0.40		34.0	90 to 110
					0.26					25			
	E115	AC110	50/60	EAC64-E115-1A	0.27		27	100 to 125	EBB64-E115	0.33		31.0	100 to 125
					0.27					27			
	E2	AC200	50/60	EAC64-E2-1A	0.15		26	180 to 220	EBB64-E2	0.22		37.0	180 to 220
					0.12					24			
E230	AC220	50/60	EAC64-E230-1A	0.13		27	200 to 250	EBB64-E230	0.17		33.0	200 to 250	
				0.13					27				0.17
DC	D1	DC12	—	EAC64-D1-1A	2.2		26	10.8 to 13.2	EBB64-D1	2.6		31.0	10.8 to 13.2
	D2	DC24	—	EAC64-D2-1A	1.1		26	21.6 to 26.4	EBB64-D2	1.5		36.0	21.6 to 26.4

Explanation of model No.

SA - G 01 - A 3 X - ** - C2 - 31

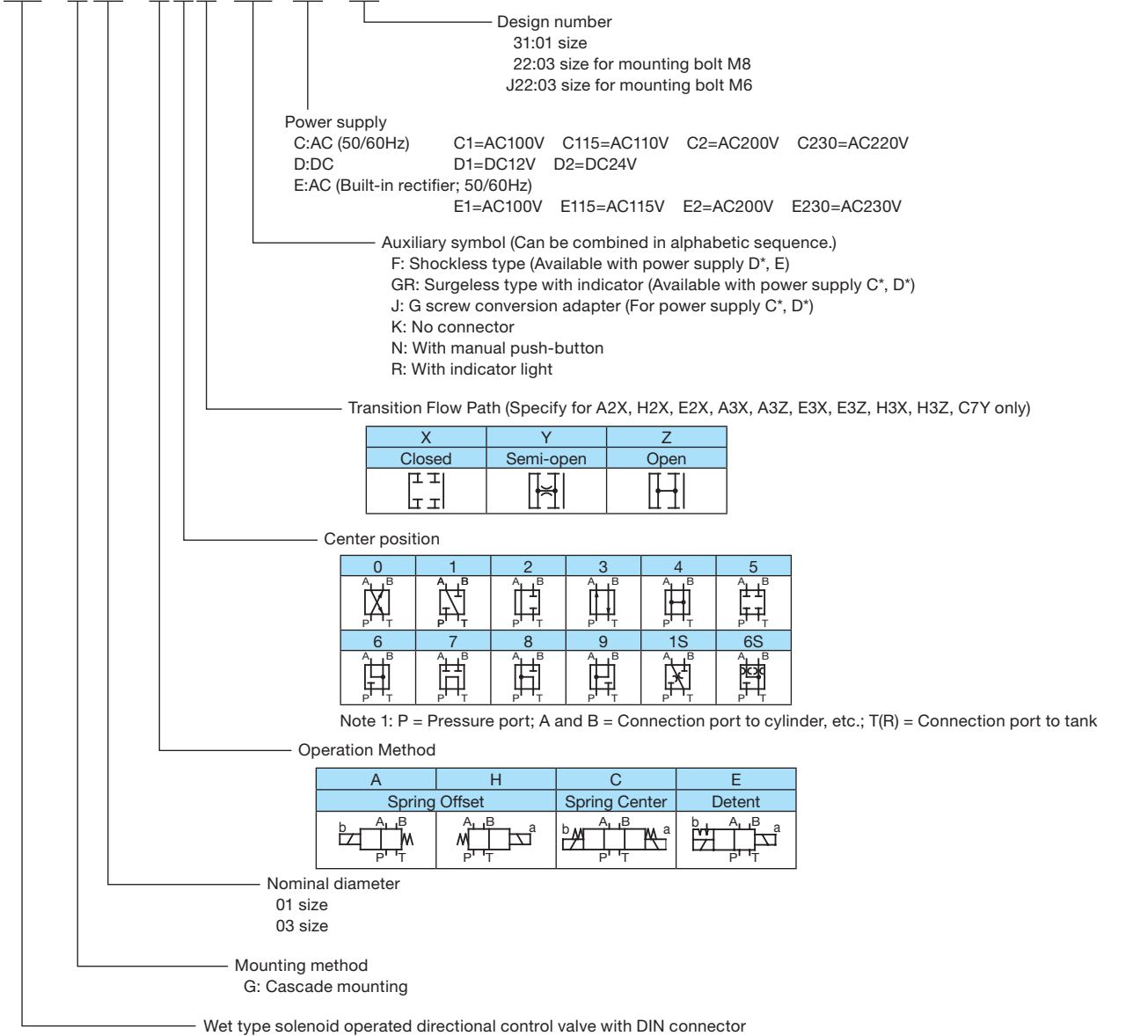

Options

(Auxiliary Symbol Explanations)

G Screw Adapter (Auxiliary Symbol: J)

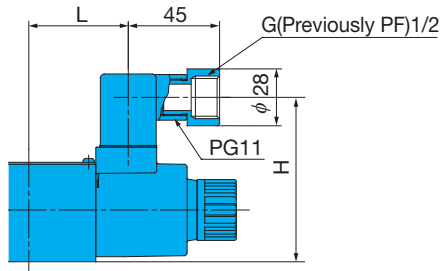

Model No.	L	H
SA-G01	49	81
SA-G03	60.5	100.5

With manual push-button (Auxiliary Symbol: N)

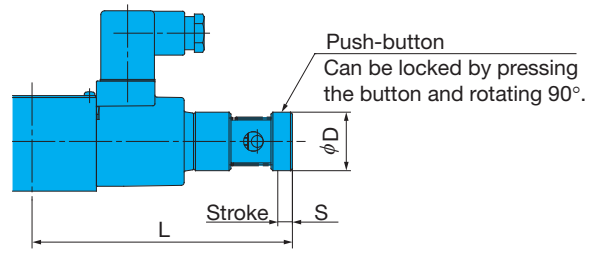

Model No.		L	S	D
SA-G01	AC Solenoid	133.5	7.5	30
	DC Solenoid	140.5		
SA-G03	AC Solenoid	155.5	9.5	35
	DC Solenoid	173.5		

Other Options

Note) For information about the shockless and surgeless options, see page E-4.

Installation Dimension Drawings

AC Solenoid
 SA-G01-A**-*-C*-31
 SA-G01-H**-*-C*-31

Note) SA-G01-H**-R**-31
 The solenoid is on the opposite side of that shown for SOLa in the illustrations shown here.

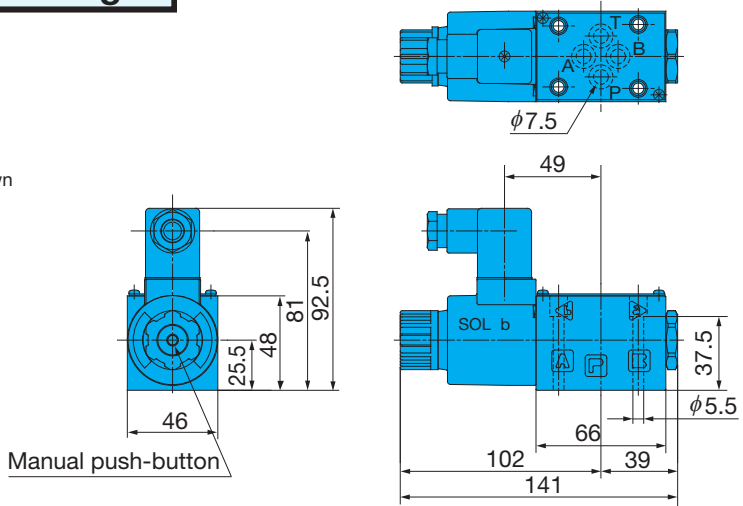

SA-G01-C**-R-C*-31
 SA-G01-E**-R-C*-31

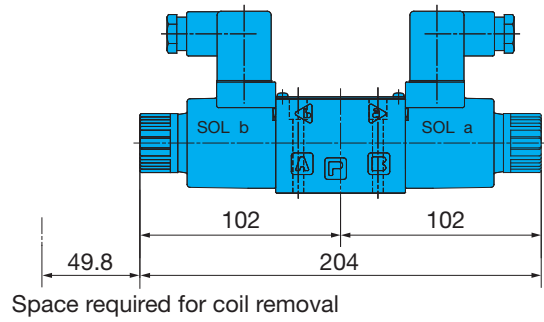

DC Solenoid and Rectifier
 SA-G01-A**-D*/E*-31
 SA-G01-H**-D*/E*-31
 SA-G01-C**-D*/E*-31
 SA-G01-E**-D*/E*-31

Note) 1. SA-G01-H**-D*/E*-31
 The solenoid is on the opposite side of that shown for SOLa in the illustrations shown here.
 2. SA-G01-**-E*-31
 Dimension 1 is 96.
 Dimension 2 is 73.

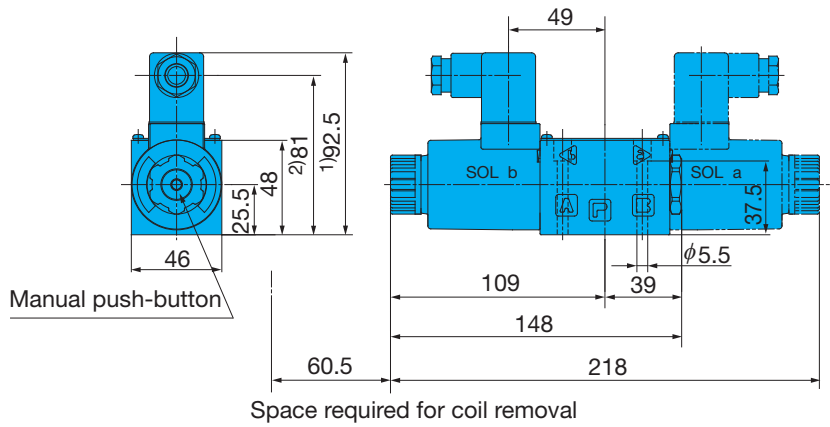

For sub plate SA-G01

Model No.	E	Weight
MSA-01X-10	1/4	1.2kg
MSA-01Y-10	3/8	1.2kg

Gasket Surface Dimensions
 (ISO 4401-03-02-0-05)
 (JIS B 8355 D-03-02-0-05)

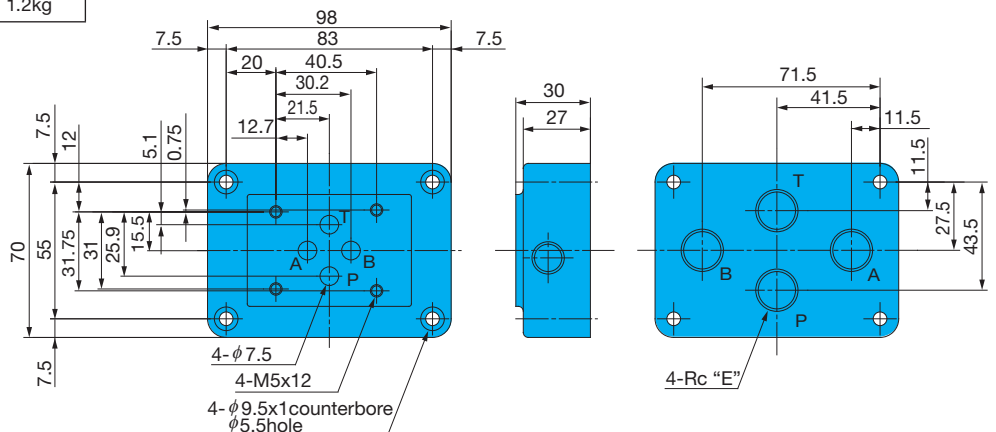

Installation Dimension Drawings

AC Solenoid
 SA-G03-A**-*-C*-J21
 SA-G03-H**-*-C*-J21

- Note 1.) SS-G03-H**-*-R**-J22
 The solenoid is on the opposite side of that shown for SOLa in the illustrations shown here.
- Note 2.) Attach the spacers to the valve, as shown in the diagram at right, to maintain the appropriate fitting length even if you do not use the installation bolts provided with the SS-G03.

	SA-G03-**-*-J21	SA-G03-**-*-21
ϕD	$\phi 6.8$	$\phi 8.5$
L	60.5	58

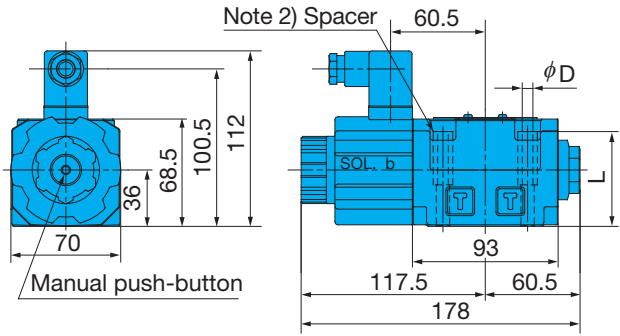
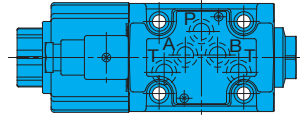

SA-G03-C**-*-C*-J21
 SA-G03-E**-*-C*-J21

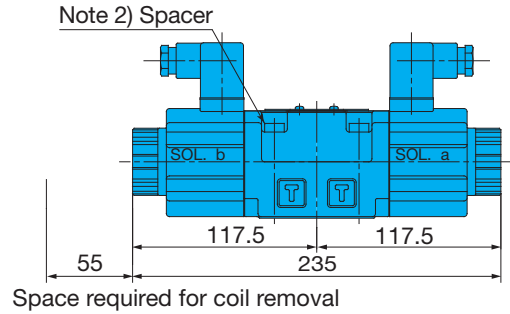

DC Solenoid and Rectifier
 SA-G03-A**-*-D*/E*-J21
 SA-G03-H**-*-D*/E*-J21
 SA-G03-C**-*-D*/E*-J21
 SA-G03-E**-*-D*/E*-J21

- Note 1.) SA-G03-H**-*-D*/E*-J21
 The solenoid is on the opposite side of that shown for SOLa in the illustrations shown here.
- 2.) SA-G03-**-*-E*-J21
 Dimension 1 is 115.5.
 Dimension 2 is 92.5.

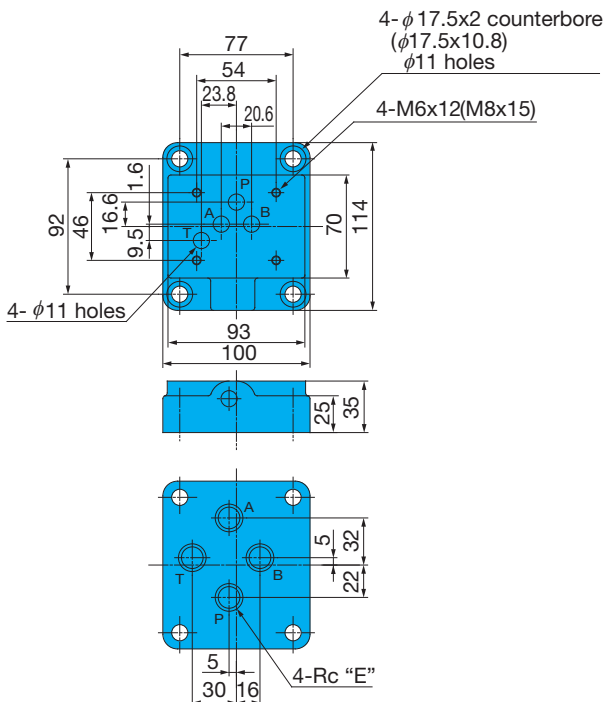
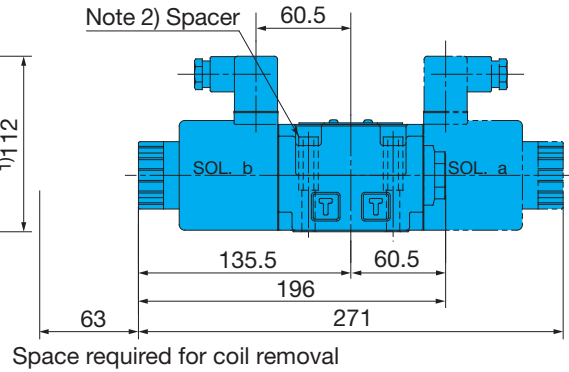
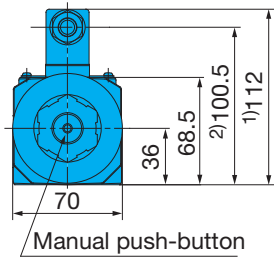



For sub plate SA-G03

Mounting bolt	Model No.	E	Weight
M6	MSA-03-10	3/8	2.3kg
	MSA-03X-10	1/2	
M8	MS-03-30	3/8	
	MS-03X-30	1/2	

M6 gasket surface dimensions
 (ISO 4401-05-04-0-05
 (JIS B 8355 D-05-04-0-05))

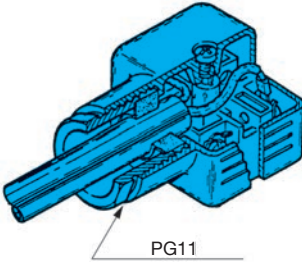
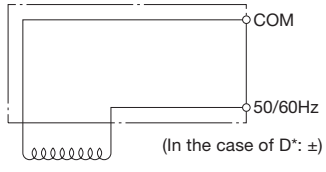
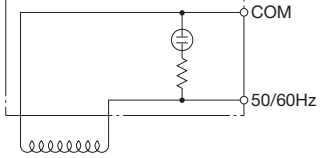
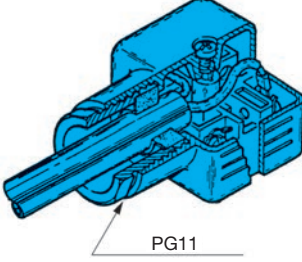
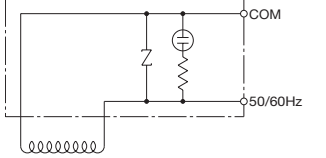
● Connectors

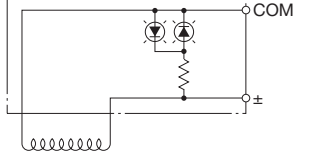
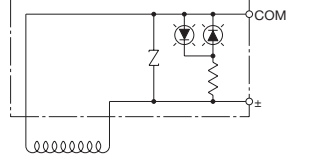
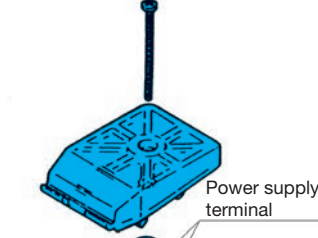
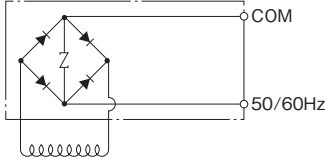
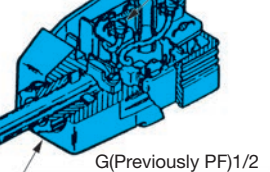
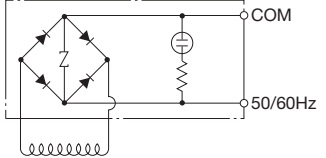
Model No.	Wiring	Electrical Circuit Diagram
SA-G01-***-C* 31 SA-G03-D* (J)21 (EA41-1A)	 <p>Connect the power supply to terminals No.1 and No. 2. The ⊕ terminal is ground. Use this terminal as required.</p>	 <p>(In the case of D*: ±)</p>
SA-G01-***-R-C* 31 SA-G03 (J)21 (EA41-R*-1C)		
SA-G01-***-GR-C* 31 SA-G03 (J)21 (EA41-GRC*-1C)		
SA-G01-***-R-D* 31 SA-G03 (J)21 (EA41-DR*-1C)		
SA-G01-***-GR-D* 31 SA-G03 (J)21 (EA41-GRD*-1C)		
SA-G01-***-E* 31 SA-G03 (J)21 (EA42-1B)		
SA-G01-***-R-E* 31 SA-G03 (J)21 (EA42-R*-1B)		

Symbols in parentheses indicate connector configuration.

Note) 1. Asterisks in the connector configuration and power supply symbols are fillers for the voltage symbol (1 or 2).

2. The connector cord diameter is ϕ 8 to ϕ 10. Anything outside this range causes water tightness to be lost.

3. The orientation of the connectors can be changed in 90° increments by changing the terminal block.

4. The cover cannot be removed unless the installation screws are removed.

5. When J is specified for the auxiliary symbol, a G screw conversion adapter is attached to the connector, and the wiring port is a G (previously PF) 1/2 screw (standard: PG11). EA42 and EA42-R* also have a G (previously PF) wiring port.

6. Use M3 for round type and Y type solderless terminals.

7. Tighten the M3 screws that secure connectors and terminals to a torque of 0.3 to 0.5N·m (3.1 to 5.1kgf·cm).

Performance Curves

Hydraulic Operating Fluid Kinematic Viscosity 32mm²/s

Pressure Loss Characteristics

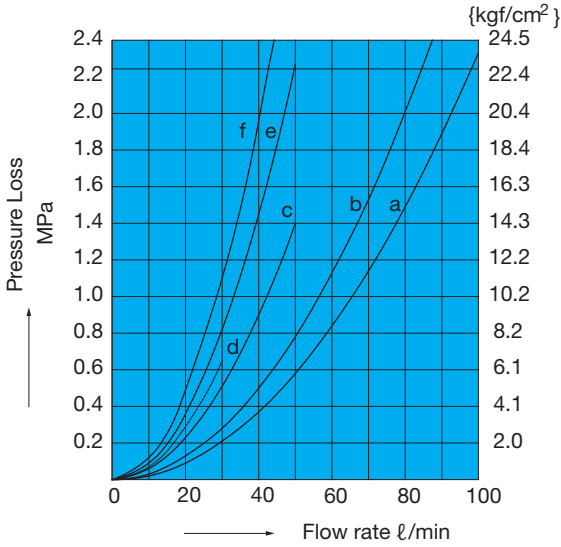

Pump Type	Flow Path	P→A	P→B	A→T	B→T	P→T
SA-G01	A2X, H2X, E2X	d	d	-	-	-
	A3X, H3X	b	b	b	b	-
	E3X	b	b	b	b	-
	A3Z, H3Z, E3Z	a	a	a	a	-
	A4, H4, C4	a	a	a	a	a
	A5, H5, C5, C6S	b	b	b	b	-
	C1, C1S	b	b	a	b	-
	C2	a	b	b	b	-
	C6	b	b	a	a	-
	C7Y	f	f	e	e	c
	C8	a	f	b	e	c
	C9	a	a	b	b	-

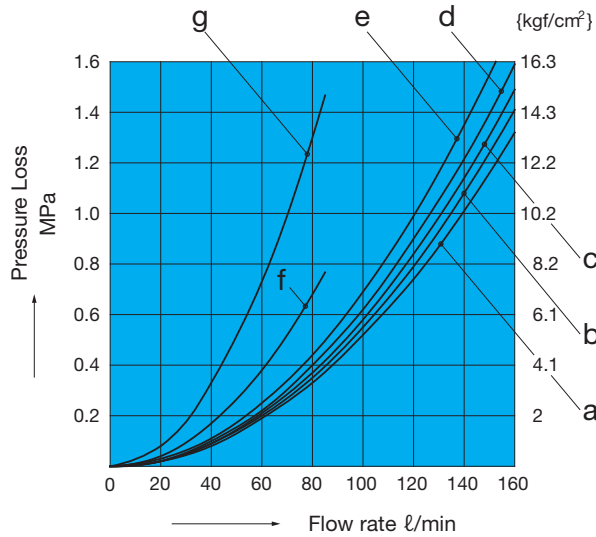

Pump Type	Flow Path	P→A	P→B	A→T	B→T	P→T
SA-G03	A2X, H2X, E2X	e	e	-	-	-
	A5	-	c	c	-	-
	H5	c	-	-	c	-
	A3X, H3X, E3X	c	c	d	d	-
	A3Z, H3Z	a	a	d	d	-
	E3Z	b	b	a	a	-
	C1	c	c	a	c	-
	C2	a	c	c	c	-
	A4, H4, C4	a	a	a	a	a
	C5, C1S, C6S	c	c	c	c	-
	C6	c	c	a	a	-
	C7Y	g	g	g	g	f
	C8	a	g	a	g	f
	C9	a	a	c	c	-

Switching Response Time

Model No.	Response Time (sec)		Measurement Conditions
	Solenoid ON	Spring Return	
SA-G01-**-*(GR)-C*-31	0.02 to 0.03	0.02 to 0.03	14MPa {143kgf/cm ² } 30l/min
SA-G01-**-*(GR)-D*-31	0.03 to 0.04	0.02 to 0.04	
SA-G01-**-*(R)-E*-31	0.03 to 0.04	0.07 to 0.10	
SA-G01-**-*(GR)-D*-31	0.07 to 0.10	0.04 to 0.07	
SA-G01-**-*(R)-E*-31	0.07 to 0.10	0.10 to 0.15	
SA-G03-**-*(GR)-C*-J21	0.02 to 0.03	0.02 to 0.03	14MPa {143kgf/cm ² } 70l/min
SA-G03-**-*(GR)-D*-J21	0.06 to 0.09	0.03 to 0.05	
SA-G03-**-*(R)-E*-J21	0.07 to 0.10	0.10 to 0.15	
SA-G03-**-*(GR)-D*-J21	0.13 to 0.15	0.08 to 0.15	
SA-G03-**-*(R)-E*-J21	0.10 to 0.15	0.15 to 0.20	

Note 1. The switching response time changes slightly with operating conditions (pressure, flow rate, viscosity, etc.)

Pressure – Flow Volume Allowable Value

Size	Standard Form, with AC, DC solenoid		
	SA-G01-**-R**-31		
Operation Example			
Operation Symbol			
A2X, H2X	–	K	K
E2X	–	J	J
A3X, H3X	B	K	K
E3X	A	J	J
A3Z, H3Z	D	D	D
E3Z	D	D	D
A5	A	–	I
H5	A	I	–
C1, C6	Note1) C(E)	I	I
C1S, C5, C6S	A	I	I
C2, C9	A	K	K
A4	F	F	F
H4	F	F	F
C4	F	F	F
C7Y, C8	Note2) G(H)	K	K

Size	Shockless Type, with DC solenoid		
	SA-G01-**-FR**-31		
Operation Example			
Operation Symbol			
A2X, H2X	–	P	P
E2X	–	O	O
A3X, H3X	L	P	P
E3X	L	O	O
A3Z, H3Z	L	L	L
E3Z	L	L	L
A5	L	–	P
H5	L	P	–
C1, C6	M	P	P
C1S, C2, C5, C6S, C9	L	P	P
A4, H4	L	L	L
C4	L	L	L
C7Y, C8	N	P	P

Note) 1. Letter in parentheses is for AC solenoid.

2. Letter in parentheses is for solenoid with built-in rectifier, but without Quick Return, and for DC solenoid with surge voltage absorbing diode on the electrical circuit.

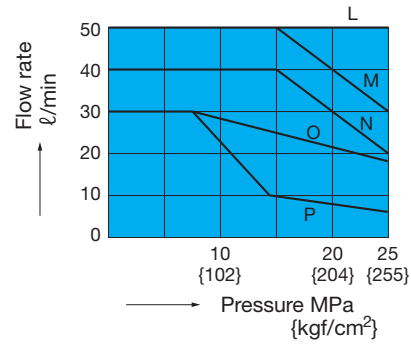
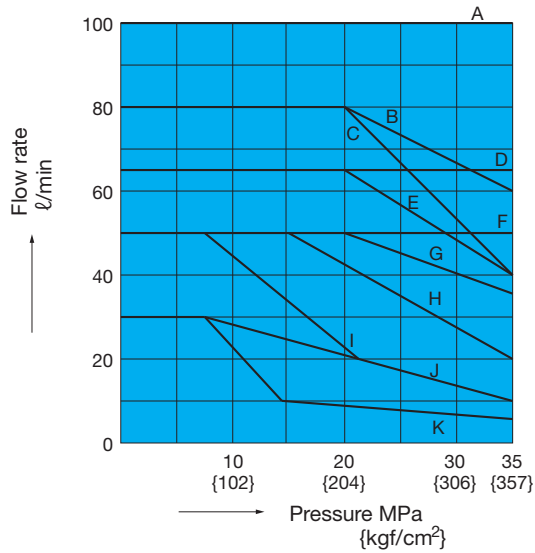

Pressure – Flow Volume Allowable Value

Model No.	Standard Form, with AC, DC solenoid			Standard Form, with DC solenoid		
	SA-G03-**-C*-J21			SA-G03-**-**-J21		
Operation Example						
Operation Symbol						
A2X	-	F	E	-	G	H
H2X	-	E	F	-	H	G
E2X	-	C	C	-	D	D
A3X	A	E	E	A	F	H
H3X	A	E	E	A	H	F
A3Z	A	A	C	A	D	D
H3Z	A	C	A	A	D	D
E3X, E3Z	A	C	C	A	D	D
A5	A	-	D	A	-	G
H5	A	D	-	A	G	-
C1S, C5, C6S	A	D	D	A	G	G
C1, C6	A	D	D	B	G	G
C2	A	G	D	A	I	G
A4, H4, C4	A	A	A	A	A	A
C9	A	G	G	A	I	I
C7Y, C8	B	B	B	Note1) C(E)	C(E)	C(E)
Model No.	Shockless Type, with DC solenoid					
	SA-G03-**-F**-J21					
Operation Example						
Operation Symbol						
A2X	-	E	F			
H2X	-	F	E			
E2X	-	C	C			
A3X	A	D	F			
H3X	A	F	D			
A3Z	A	C	C			
H3Z	A	C	C			
E3X, E3Z	A	C	C			
A5	A	-	E			
H5	A	E	-			
C1, C1S, C5, C6, C6S	A	E	E			
C2	A	G	E			
A4, H4, C4	A	A	A			
C9	A	G	G			
C7Y, C8	Note1) B(H)	B(H)	B(H)			

- Note) 1. Letter in parentheses is for solenoid with built-in rectifier (E*), but without Quick Return, and for DC solenoid (D*) with surge voltage absorbing diode on the electrical circuit.
 2. There is no shockless type for the AC solenoid (C*), so use a solenoid with built-in rectifier (E*) when shockless operation is required with an AC power supply.
 3. The maximum flow rate is the allowable value of each port.

Cross-sectional Drawings

SA-G01-A**-C*-31

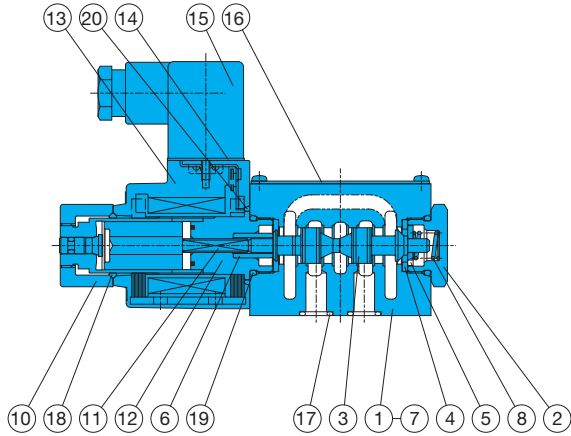

SA-G01-C**-C*-31

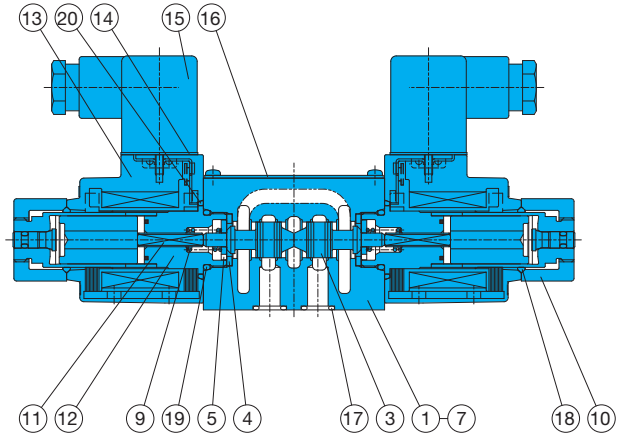

SA-G01-A**-D/E*-31

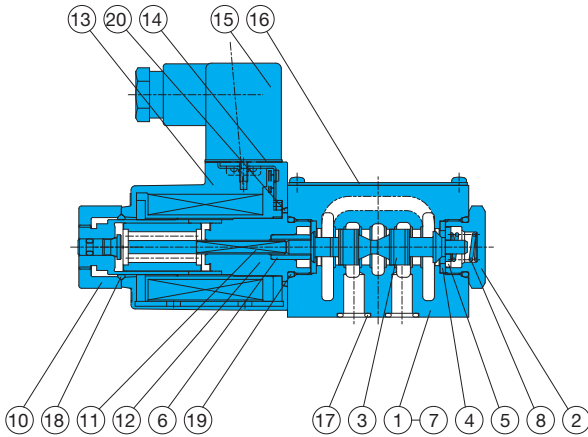

SA-G01-C**-D/E*-31

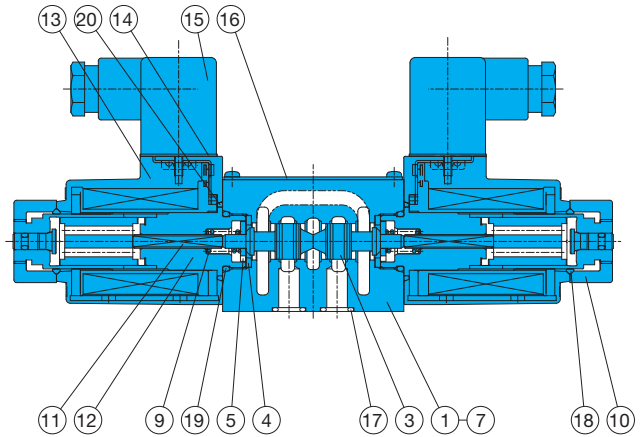

List of Sealing Parts

Part No.	Part Name	Part Number	Q'ty	
			Single Solenoid	Double Solenoid
17	O-ring	AS568-012(NBR-90)	4	4
18	O-ring	NBR-70-1 P20	1	2
19	O-ring	NBR-90 P18	2	2
20	O-ring	S-25(NBR-70-1)	1	2

Note) The materials and hardness of the O-ring conforms with JIS B2401.

Seal Kit Number

Single Solenoid	Double Solenoid
EDCS-A	EDCS-C

Part No.	Part Name	Part No.	Part Name
1	Body	11	Rod
2	Plug	12	Solenoid guide
3	Spool	13	Solenoid coil
4	Retainer A	14	Packing
5	Retainer B	15	Connector
6	Spring pin	16	Nameplate
7	Spacer	17	O-ring
8	Spring A	18	O-ring
9	Spring C	19	O-ring
10	Nut	20	O-ring



Cross-sectional Drawings

SA-G03-A**-C*-(J)21

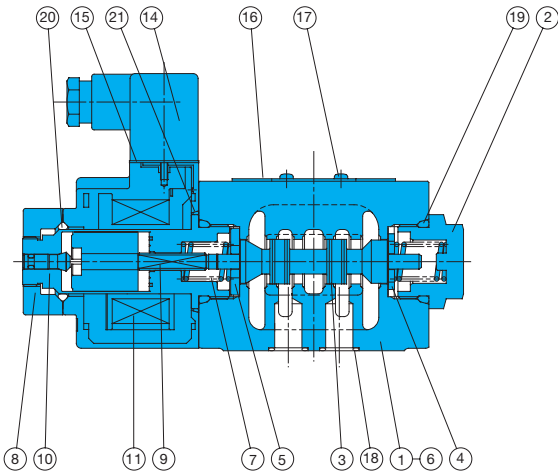

SA-G03-C**-C*-(J)21

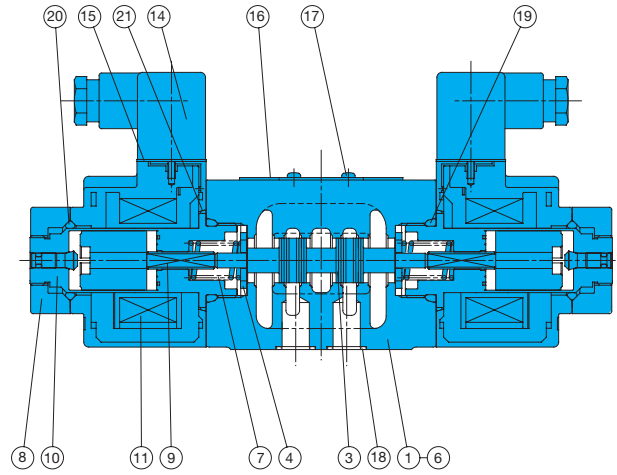

SA-G03-A**-D/E*-(J)21

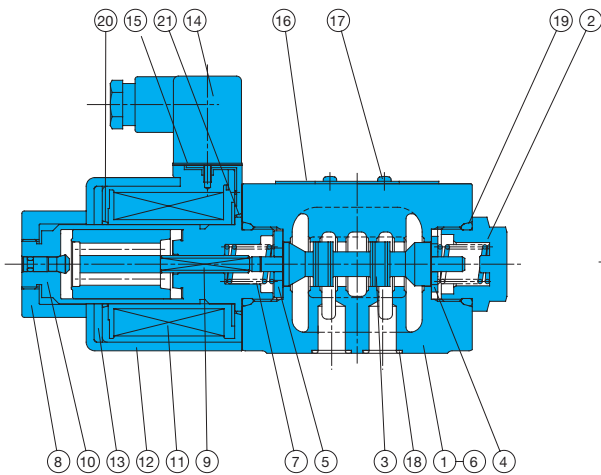

SA-G03-C**-D/E*-(J)21

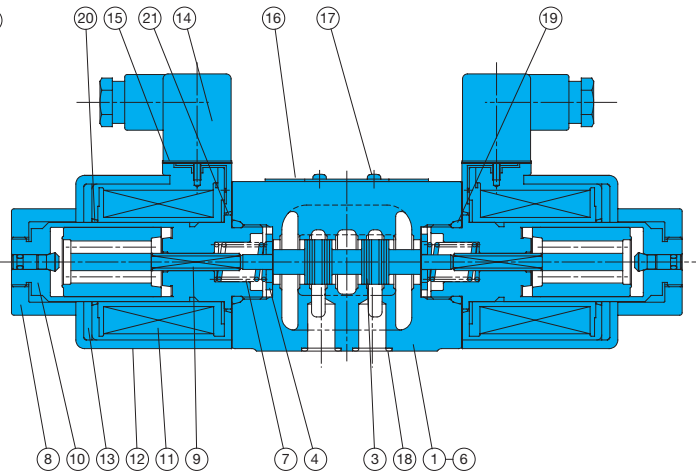

List of Sealing Parts

Part No.	Part Name	Type/Part Number		Q'ty	
		AC SOL.	DC SOL.	Single Solenoid	Double Solenoid
18	O-ring	AS568-014(NBR-90)		5	5
19	O-ring	NBR-90 P28		2	2
20	O-ring	NBR-70-1 P26	AS568-026(NBR-70-1)	1	2
21	O-ring	AS568-029(NBR-70-1)		1	2

Note) The materials and hardness of the O-ring conform with JIS B2401.

Part No.	Part Name	Part No.	Part Name
1	Body	11	Solenoid coil
2	Plug	12	Coil case
3	Spool	13	Coil yoke
4	Retainer	14	Connector
5	Retainer B	15	Connector packing
6	Spacer	16	Nameplate
7	Spring	17	Screw
8	Nut	18	O-ring
9	Rod	19	O-ring
10	Solenoid guide	20	O-ring
		21	O-ring

Seal Kit Number

AC SOL.		DC SOL.	
Single Solenoid	Double Solenoid	Single Solenoid	Double Solenoid
ECBS-AA	ECBS-CA	ECBS-AD	ECBS-CD