

SNH Series Non-leak Type Solenoid Valve

20 to 100ℓ/min
35MPa



Features

① Virtually no internal leakage

A poppet structure minimizes internal leaks from low pressures to as high as 35MPa {357kgf/cm²}. Enhanced hydraulic circuit efficiency reduces energy needs.

② Virtually no pressure loss at high volumes

An original fluid reaction force suppression mechanism is provided for all sizes. Though compact, this valve provides the highest level switching capacity for its class.

③ High reliability

Since a wet type solenoid valve is used, the movable iron core remains immersed in oil as it moves, which minimizes switching noise and ensures reliable operation.

A wet type valve also provides superior water resistance and longer life than a dry type valve.

④ ISO standard mounting service (01, 03 sizes)

This valve can be ganged together with a modular valve, enabling simple configuration of circuits and an overall

compact device configuration.

⑤ EC connector for improved switching (06 size)

During switching, twice the current (starting current) flows to the coil than normal (holding current), which ensures reliable switching operations. The 06 size has compact configuration made possible by an original design that uses a small coil that provides high output, without the need for a large coil.

Specifications

Model No.		SNH-G01	SNH-G03	SNH-G04	SNH-G06	
JIS Symbol	AR					
	HQ					
	A2K					
Maximum Working Pressure MPa{kgf/cm ² } (P, A, B Ports)		35{357}				
Rated Flow Rate - Maximum Flow Rate ℓ/min		AR,HQ;10-20 A2K; 5-20	20-40	40-60	60-100	
Maximum Changeover Frequency (per minute)		120				
Operating Environment	Dust Resistance/Water Resistance Rank	JIS C 0920 IP65(Dust-tight, Waterjet-proof) (Note 2)			IP64 (Dust-tight, Splash-proof)	
	Ambient Temperature	-20 to 50°C				
	Operating Fluid	Temperature Range	-20 to 70°C			
		Kinematic Viscosity Range	15 to 300mm ² /s			
		Filtration	25 μm or less			
Weight AR-HQ(A2K)kg		1.8(2.2)	5.2	5.5	6.9	
Mounting bolt	Size x Length	M5x45 (Four)	M8x70 (Four)	M8x70 (Four)	M10x75 (Four)	
	Tightening Torque N·m{kgf·cm}	6 to 8 {61 to 81}	30 to 35 {306 to 357}	30 to 35 {306 to 357}	55 to 60 {561 to 612}	

- Note 1. Internal leaking does not exceed 1 droplet/minute (0.05cm³/min).
 2. The power supply type for E* is IP64 (dust-tight, splash-proof).
 3. For mounting bolts, use bolts of 12.9 strength classification or equivalent.
 4. Mounting bolts are not included with the 01 size. Bolts are included with the 03, 04, 06 sizes.

● Handling

- Take care so the B port is not subjected to abnormal surge pressure that is in excess of the maximum operating pressure.
- The manual switching (options M, N) push pin receives B port pressure, so it cannot be pushed with pressure in excess of about 5 MPa {51 kgf/cm²}. Also, note that with the HQ and A2K types, even if the manual switching push button (option N) is locked, leaks are not completely stopped.
- Use this valve only within the allowable voltage range.
- Use of water- or glycol-based hydraulic operating fluid is standard. Contact your agent about using other fire-resistant hydraulic fluid.
- Always keep the operating fluid clean. Allowable contamination is class NAS12 or less.
- In order to realize the full benefits of the wet type solenoid valve, configure piping so oil is constantly supplied to the B port.
- The coil surface temperature increases if this valve is kept continuously energized. Install the valve so there is no chance of it being touched directly by hand.
- Never try to take this valve apart. The cap seal cannot be reassembled without using special tools.

● Solenoid Assembly Specifications (SNH-G01)

Solenoid Type	Power Supply Type	Voltage (V)	Frequency (Hz)	For SNH-G01				For SNH-G03			
				Solenoid Coil Type	Current (A)	Power (W)	Allowable Voltage Range (V)	Solenoid Coil Type	Current (A)	Power (W)	Allowable Voltage Range (V)
DC with Built-in Rectifier	E1	AC100	50/60	EAC64-E1-1A	0.31	27	90 to 110	EBB64-E1	0.40	34	90 to 110
	E115	AC110	50/60	EAC64-E115-1A	0.26	25	100 to 125	EBB64-E115	0.33	31	100 to 125
		AC115			0.27	27			0.34	34	
	E2	AC200	50/60	EAC64-E2-1A	0.15	26	180 to 220	EBB64-E2	0.22	37	180 to 220
E230	AC220	50/60	EAC64-E230-1A	0.12	24	200 to 250	EBB64-E230	0.16	30	200 to 250	
	AC230			0.13	27			0.17	33		
DC	D1	DC12	-	EAC64-D1-1A	2.2	26	10.8 to 13.2	EBB64-D1	2.6	31	10.8 to 13.2
	D2	DC24	-	EAC64-D2-1A	1.1	26	21.6 to 26.4	EBB64-D2	1.5	36	21.6 to 26.4

● Solenoid Assembly Specifications (SNH-G03, G04)

Solenoid Type	Power Supply Type	Voltage (V)	Frequency (Hz)	For SNH-G04			
				Solenoid Coil Type	Current (A)	Power (W)	Allowable Voltage Range (V)
DC with Built-in Rectifier	E1	AC100	50/60	EBB64-E1	0.40	34	90 to 110
	E2	AC200	50/60	EBB64-E2	0.22	37	180 to 220
DC	D2	DC24	-	EBB64-D2	1.5	36	21.6 to 26.4

● Solenoid Assembly Specifications (SNH-G06)

Solenoid Type	Power Supply Type	Voltage (V)	Frequency (Hz)	For SNH-G06				
				Solenoid Coil Type	Drive Current (A)	Holding Current (A)	Holding Power (W)	Allowable Voltage Range (V)
DC with Built-in Rectifier	E1	AC100	50/60	EBB64-D60	0.71	0.36	33.2	90 to 110
	E2	AC200	50/60	EBB64-D120	0.39	0.19	36.4	180 to 220
DC	D2	DC24	-	EBB64-D17	3.0	1.5	37.4	21.6 to 26.4

Explanation of model No.

SNH - G 01 - AR - * - D2 - 11

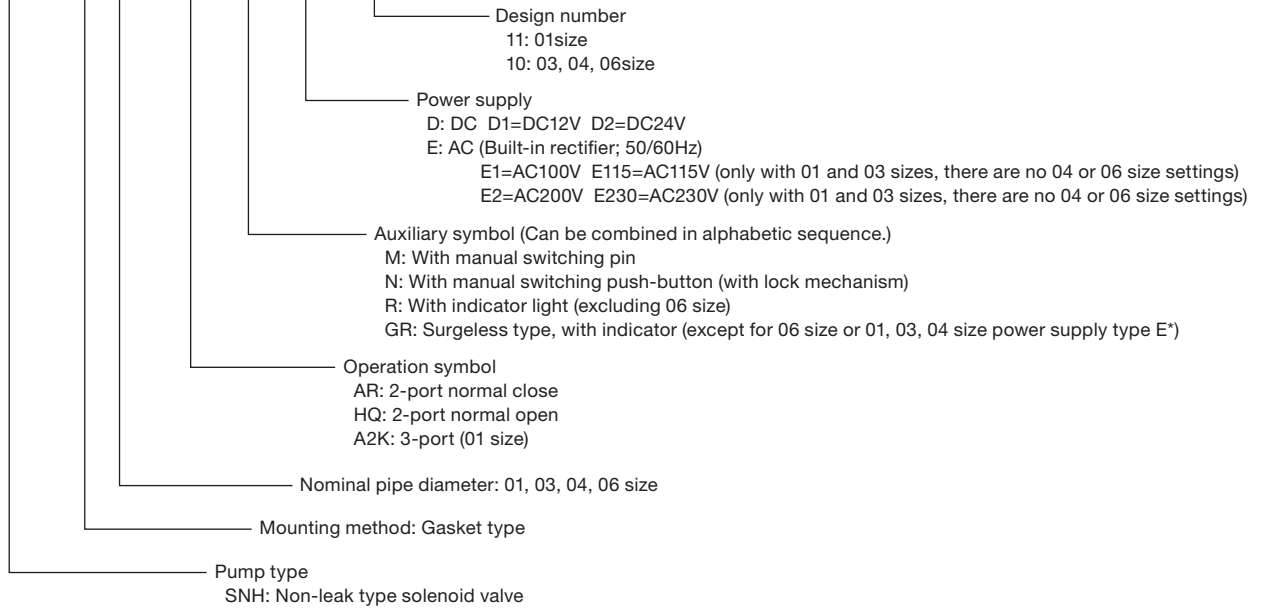

Options

(Auxiliary Symbol)

- Select options in accordance with size, as shown in the table to the right.
 - The 06 size has an EC connector and a built in surge killer as standard. However, an indicator light is not provided because of space considerations.
 - Option N increases the measurement by the size of the pushbutton only.

Size	Auxiliary symbol			
	M	N	R	GR
01	○	○	○	○
03	○	○	○	○
04	○	○	○	○
06	○	○	—	—

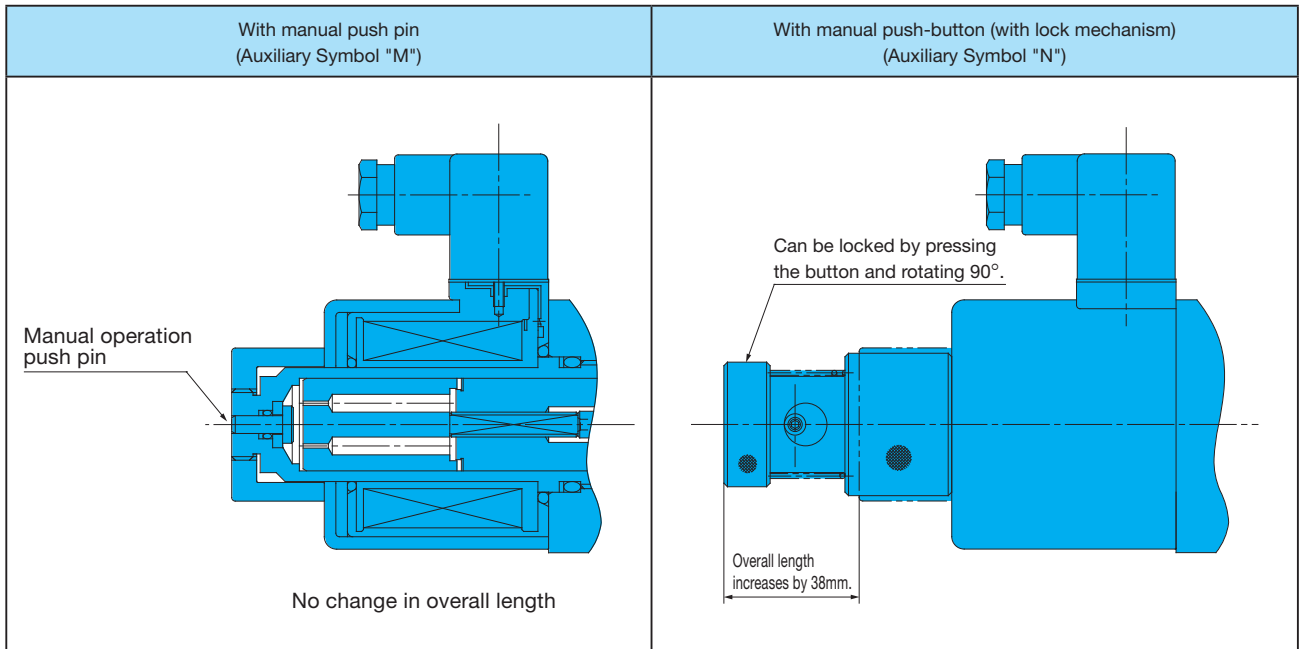

Electrical Circuits

• These electrical circuits are for sizes 01, 03, 04. An EC connector is used for size 06. See the next page for more information.

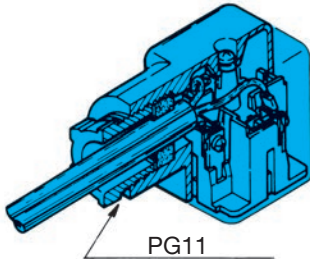
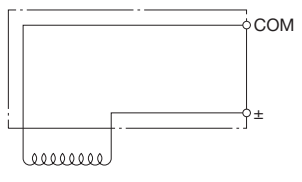
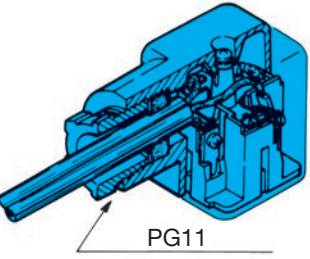
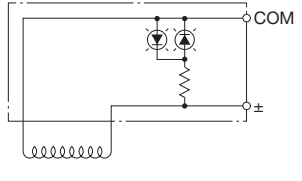
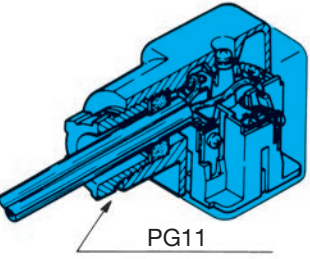
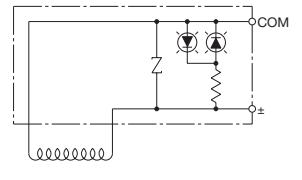
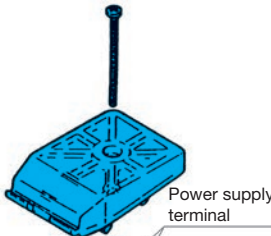
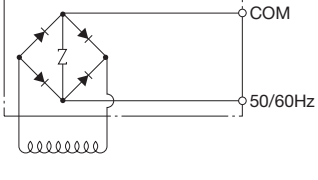
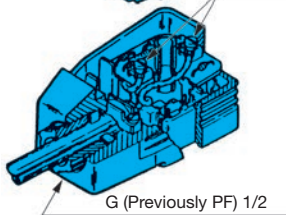
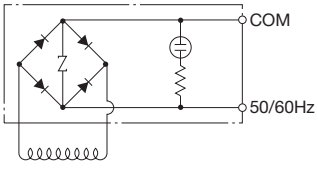
Valve	Connector Type	Wiring	Electrical Circuit Diagram
G01 G03 G04 Size	EA41-1A (Standard for power supply type D*)	 <p>PG11</p> <p>Connect the power supply to terminals No.1 and No. 2. The ⊕ terminal is ground. Use this terminal as required.</p>	
	EA41-DR1/2-1C (D* option: R)	 <p>PG11</p> <p>Connect the power supply to terminals No.1 and No. 2. The ⊕ terminal is ground. Use this terminal as required.</p>	
	EA41-GRD1/2-1C (D* option: GR)	 <p>PG11</p> <p>Connect the power supply to terminals No.1 and No. 2. The ⊕ terminal is ground. Use this terminal as required.</p>	
	EA42-1B (For power supply type E*)	 <p>Power supply terminal</p> <p>Connect the power supply to the ⊕ terminals on the board. When ground connection is required, remove the board and use the terminal. In this case, do not connect the power supply to the No. 1 and No. 2 terminals.</p>	
EA42-R1/2-1B (E* option: R)	 <p>G (Previously PF) 1/2</p> <p>Connect the power supply to the ⊕ terminals on the board. When ground connection is required, remove the board and use the terminal. In this case, do not connect the power supply to the No. 1 and No. 2 terminals.</p>		

- Note) 1. Connector types 1 and 2 indicate voltage. (1: 100V AC or 12V DC; 2: 200V AC or 24V DC)
 2. Use a connector cord with a diameter that is in the range of $\phi 8$ to $\phi 10$.
 3. The orientation of the connectors can be changed in 90° increments by modifying the terminal block.
 4. The cover cannot be removed unless the installation screws are removed.
 5. Use an M3 type as a solderless terminal.
 6. Tighten the M3 screws that secure connectors and terminals to a torque of 0.3 to 0.5N·m (3 to 5.1kgf·cm).

●06 Size EC Connector

SNH-G06 provides large switching power, so an EC connector is used. During switching, this EC connector supplies twice the current (starting current) that normally flows to the coil (holding current), and drops the current back to normal after switching is complete.

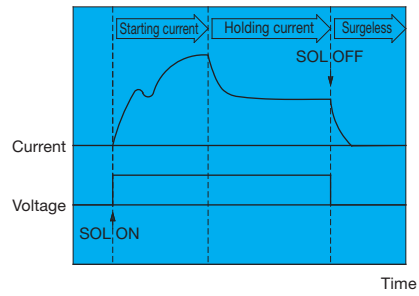

Valve	Connector Type	Wiring	Electrical Circuit Diagram
06 Size	Surgeless Type (24V DC) EC Connector EN41-06D2	<p>Power supply terminal</p>	<p>Note that correct polarity must be maintained with the power supply.</p>
	Built-in Rectifier EC Connector EN41-06E1/E2	<p>G (Previously PF) 1/2</p> <p>Connect the power supply to the terminals on the board. When ground connection is required, remove the board and use the ⊕ terminal. In this case, do not connect the power supply to the No. 1 and No. 2 terminals. Round type, Y type, and other solderless terminals cannot be used.</p>	

Note) The orientation of the EN41-06** connector cannot be changed at 90° intervals by modifying the terminal block.

Installation Dimension Drawings

SNH-G**-AR**-**₁₁
10

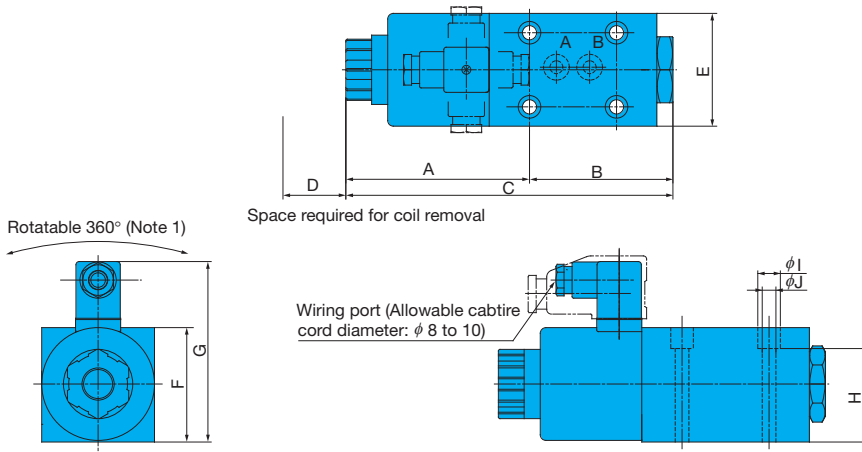

Valve Mounding Surface Dimensions

01-AR/HQ(Conforms to ISO 4401-03-02-0-05)

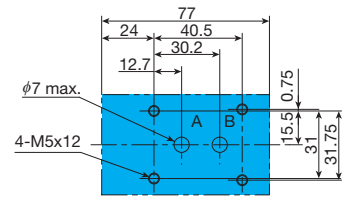

03-AR/HQ(Conforms to ISO 4401-05-04-0-05)

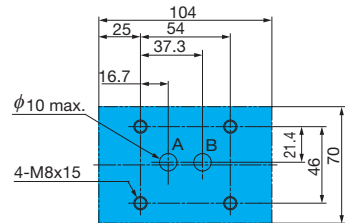

Note) An M6 mounting screw type is not yet available.

04-AR/HQ

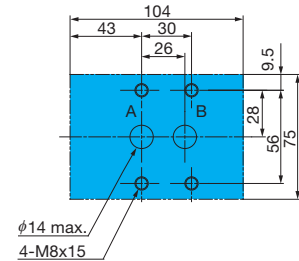

06-AR/HQ

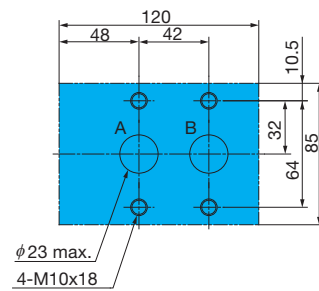

Dimension Table

Size	A	B	C	D	E	F	G(Note) ₂	H	I	J
01	100	60.5	160.5	60.5	46	48	91 (94.5)	37.5	9	5.5
03	114	89	203	63	70	72	112 (115.5)	58	14	8.5
04	132	71	203	63	75	71	112 (115.5)	58	14	8.5
06	137	82	219	63	85	71	115.5	60	18	11

Note) 1. The 01, 03, 04 size power supply type E* allows rotation at 90° intervals, but the 06 size cannot be rotated.

2. Values in parentheses are for 01, 03, 04 size power supply type E*.

3. The P and T ports of the 01, 03 sizes do not have O-ring grooves, so if the manifold has P and T ports, use end plates to close off the valve P and T ports. Contact your agent for information about end plates.

SNH-G**-HQ**-**₁₁
10

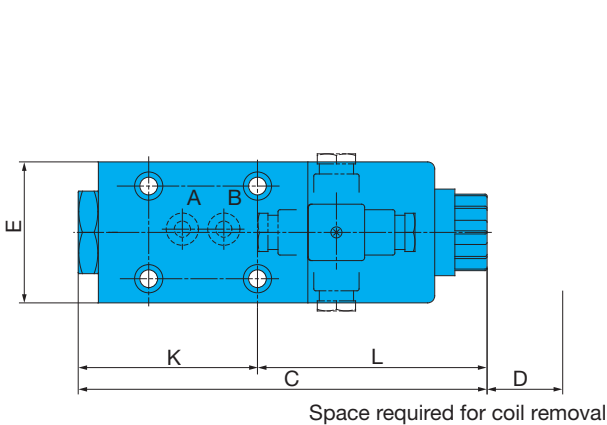

Dimension Table

Size	C	D	E	F	G(Note) ₂	K	L
01	160.5	60.5	46	48	91 (94.5)	70.5	90
03	203	63	70	72	112 (115.5)	89	114
04	203	63	75	71	112 (115.5)	83	120
06	219	63	85	71	115.5	100	119

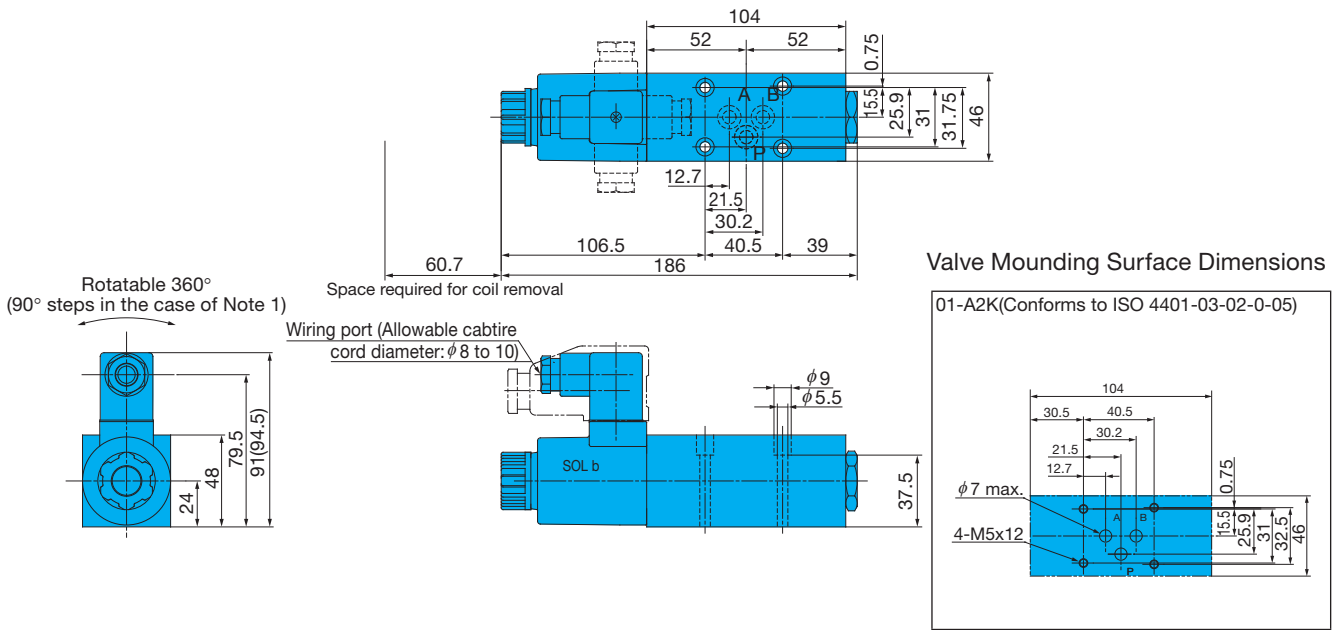

Note) 1. Power supply type E* allows rotation at 90° intervals.
 2. Values in parentheses are for power supply type E*.

Performance Curves

Hydraulic Operating Fluid Kinematic Viscosity 32mm²/s

Pressure Loss Characteristics

Flow Path	Size			
	01	03	04	06
A↔B	a	b	c	d
P↔A, P↔B	a	—	—	—

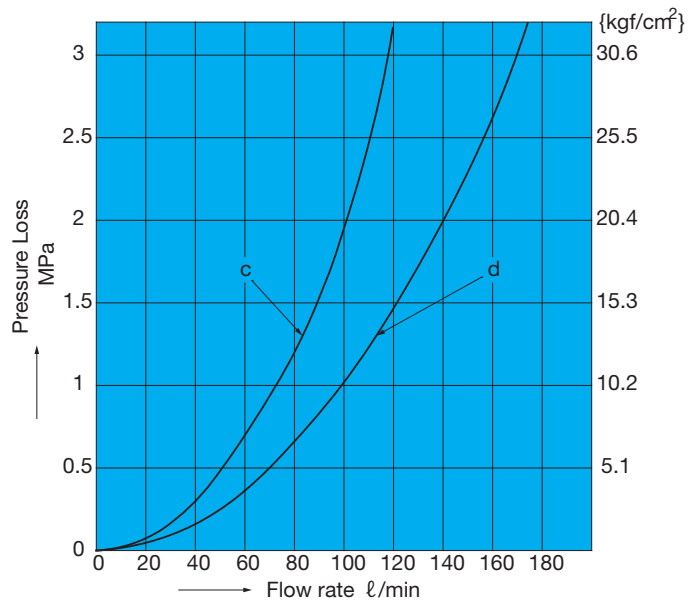
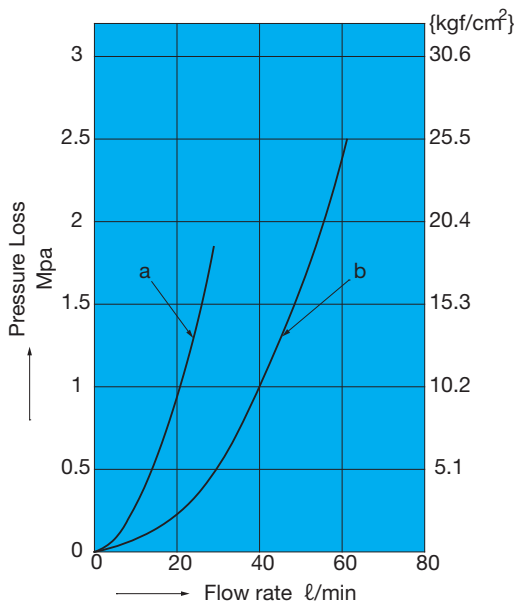

Pressure - Flow Volume Allowable Value

G01 Size

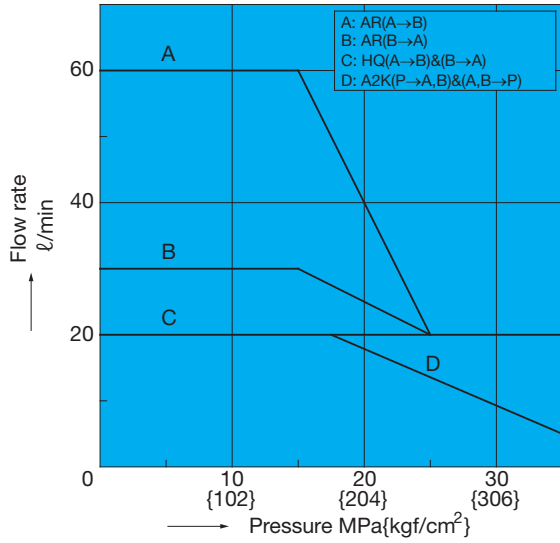

G03 Size

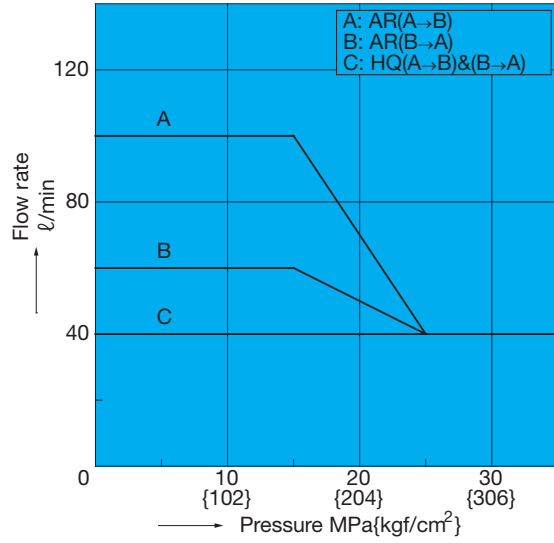

SNH-G04-AR/HQ

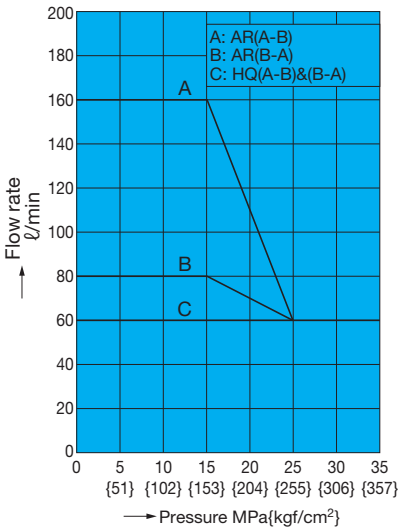

SNH-G06-AR/HQ

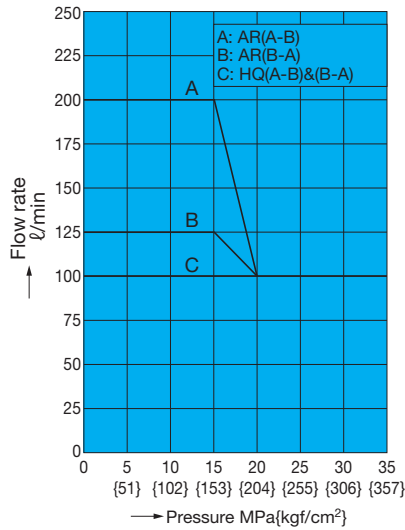

Note) Available flow rate values depend on pressure and fluid flow direction. The following shows how to read the data.

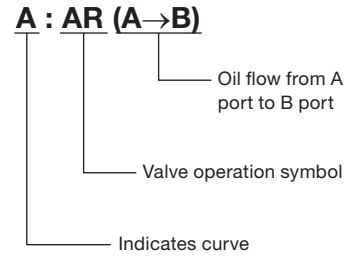

Switching Response Time

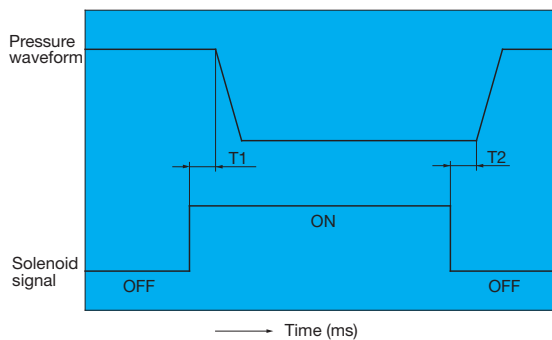

Pressure : 35MPa{357kgf/cm²}
 Flow Rate : 01 : 20l/min
 03 : 40l/min
 04 : 60l/min
 06 : 100l/min
 Operating Fluid : ISO VG68

Size	Power supply	Response Time (SEC)	
		T1 (ON)	T2 (OFF)
01	D*	0.03 to 0.05	0.04 to 0.06
	E*	0.04 to 0.06	0.08 to 0.10
03	D*	0.06 to 0.08	0.04 to 0.06
	E*	0.07 to 0.09	0.08 to 0.10
04	D*	0.09 to 0.11	0.06 to 0.08
	E*	0.12 to 0.14	0.14 to 0.16
06	D*	0.04 to 0.06	0.06 to 0.08
	E*	0.09 to 0.11	0.14 to 0.16

Note) The switching response time changes slightly with operating conditions (pressure, flow rate, viscosity, etc.)

Cross-sectional Drawings

SNH-G01-AR-**-11

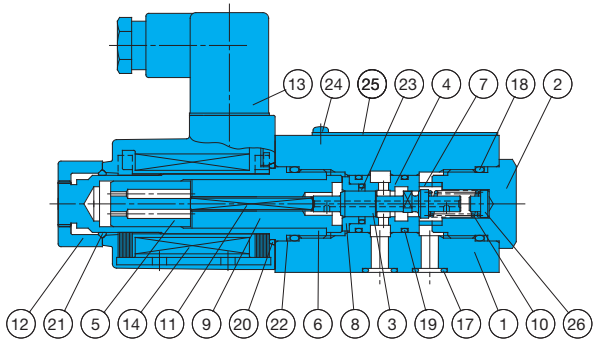

SNH-G01-HQ-**-11

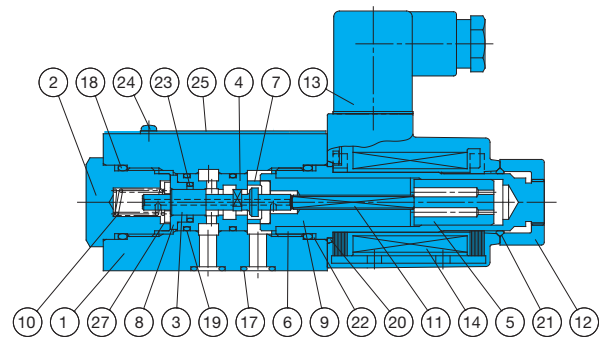

SNH-G01-A2K-**-11

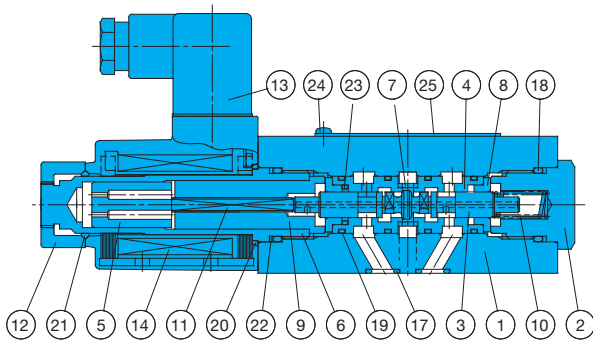

Part No.	Part Name	Part No.	Part Name
1	Body	15	Coil case
2	Plug	16	Coil yoke
3	Poppet	17	O-ring
4	Sleeve	18	O-ring
5	Plunger	19	O-ring
6	Solenoid guide	20	O-ring
7	Ring	21	O-ring
8	Collar	22	Backup ring
9	Solenoid stopper	23	Cap seal
10	Spring	24	Cross recessed head small screw
11	Rod	25	Nameplate
12	Nut	26	Stopper
13	Connector	27	Retainer
14	Solenoid coil		

03

SNH-G04 -AR-**-10

06

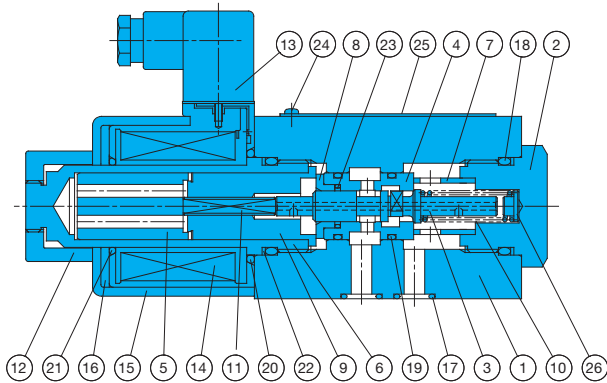

03

SNH-G04 -HQ-**-10

06

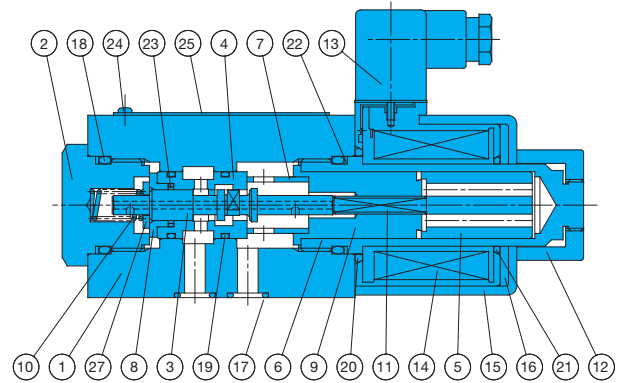

List of Sealing Parts

Part No.	Part Name	01	03	04	06	Q'ty	
						AR,HQ	A2K
17	O-ring	AS568-012(NBR-90)	NBR-90 P12	NBR-90 P16	NBR-90 P28	2	3
18	O-ring	NBR-90 P22	NBR-90 P32	NBR-90 P32	NBR-90 P32	2	2
19	O-ring	AS568-017(NBR-90)	NBR-90 P22	AS568-120(NBR-90)	NBR-90 P26	2	4
20	O-ring	S-25(NBR-70-1)	AS568-029(NBR-70-1)	AS568-029(NBR-70-1)	AS568-029(NBR-70-1)	1	1
21	O-ring	NBR-70-1 P20	AS568-026(NBR-70-1)	AS568-026(NBR-70-1)	AS568-026(NBR-70-1)	1	1
22	Backup ring	T2-P22	T2-P32	T2-P32	T2-P32	2	2
23	Cap seal	*	*	*	*	1	1

Note) The materials and hardness of the O-ring conforms with JIS B2401. Backup ring T2 indicates JIS B 2407-T2.

Parts marked by an asterisk "" are not available on the market. Contact your agent for more information.

